

KITCHEN INSTALLATION AND STORAGE AIDS

Adjustable base cabinet legs have several significant advantages:

1. They permit use of less material (expect to get 6 cabinet panels per 4x8 sheet, rather than the usual 5).
2. They permit easy leveling, easy installation.
3. Cabinets do not interfere with pipes or cables.
4. Cabinets are held above area flooding.
5. Toe-kicks are easily removed for cleaning, and extermination.

<u>Stock #</u>	<u>Dimensions</u> (HxØ)
PLSOCKET	22mm x 60mm
TOEKICKSCR	--
TOEKICKGRV	--
WHCOVERCAP	--
4LEG	77mm x 28mm
6LEG	127mm x 28mm
FOOT	20mm x 48mm

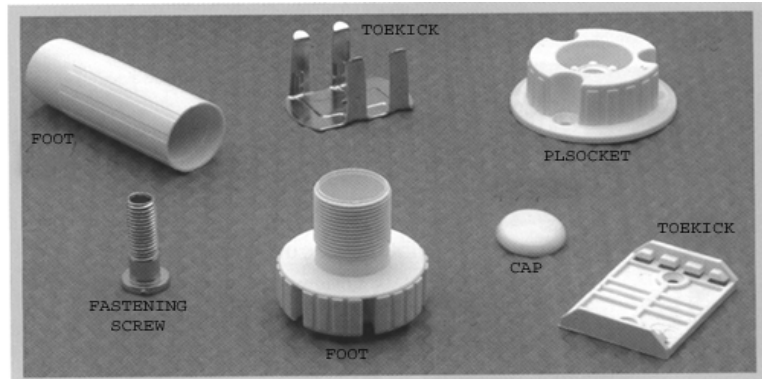

The **PLSOCKET** is attached to the bottom of the cabinet with a 10mm hollow screw – included (a metal screw version is also available).

The **TOEKICKSCR** is a screw-on clip while the **TOEKICKGRV** is a knock-in version which presses into a 1/8" groove cut into the back of the toe kick.

We carry white cover caps, **WHCOVERCAP**, if covering of the hollow screw is desired.

4LEG is a 4" plastic leg tube and **6LEG** is a 6" plastic leg tube.

FOOT is a 1" diameter plastic adjustable foot.

Features:

- Adjustability
- Provides access underneath cabinets
- Reduces material usage
- portability

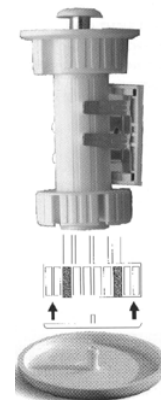

Fully Assembled Leveler

TAMBOUR

Tambour products are manufactured by National Products, Inc., of Louisville, KY.

Tambour

- Is manufactured with individually molded slats
- Has poly/cotton cloth backing -not susceptible to finishing products
- Panels have 2 lead slats -one at each end
- Is shipped to you from our stock-cleaned, pre-flexed and sanded -ready to accept stain and topcoats.

Stock Number	Slat Length	Height	Species of Wood
V348X36RO	47-1/2"	36"	Red Oak

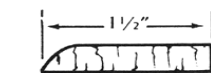
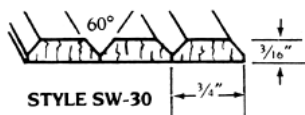

Veneer

Configuration of Tambour stocked

Configuration of lead rail

SPRING TENSION TAMBOUR TRACK KITS

Frameless Mount

- Kit includes plastic guide rails which are recessed or flush mounted to end panels of frameless cabinet
- Includes tension spring and donut(s) for tambour door attachment
- Stocked for door widths up to 24"
- White color
- Suitable for door height up to 19"
- Stock number **ST3X24WH**

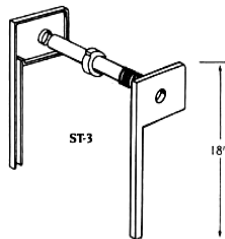

Face Frame Suitable

- Kit includes plastic guide rails to be stapled or screwed to face frame
- Includes tension spring and donut(s) for tambour door attachment
- Stocked for door widths up to 24"
- Almond color
- Suitable for door height up to 19"
- Stock number **ST2X24AL**

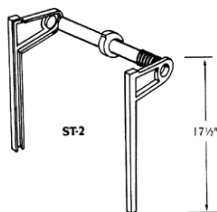

TAMBOUR TRACK SYSTEMS –PVC

- Extruded, rigid PVC -ideal for all types of furniture and cabinets
- Suitable for both small and large tambour doors
- Track can be either recessed in routed groove or stapled directly to end panels
- Recessed area in bottom of track for staples
- Can be butted to form "U" shape
- Accepts maximum door thickness of 3/16" (our stock thickness)
- Brown color
- Stock number **LT22X22BR**

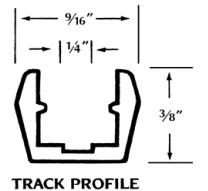
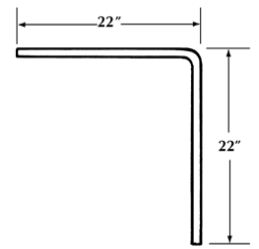

TRACK PROFILE

COMBINATION SETS (everything you need)

Kits include:

- Quality tambour door and spring tension tambour track system, packed together in a carton
- Unique, problem free, almond track system provided for face frame mounting
- Track system consists of 2 PVC guide rails, wood dowel, donut(s), door attachment and tension spring
- Solid wood tambour doors feature individual slat lay up and poly/cotton fabric backing
- Doors have solid wood hand pull

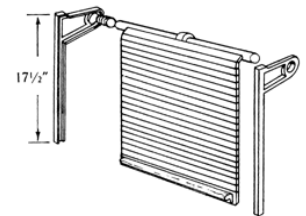

Red Oak **24" Width x 18-1/2"**
SW30X24ST2RO

30" Width x 18-1/2"
SW30X30ST2RO

APPLIANCE GARAGE KITS – STRAIGHT UNITS

- 18-1/2" high x 11-7/8" deep with 24 wide face frame
- kit is complete with tambour door mounted to solid wood face frame
- kits utilize the Spring Tension Track System ST2X24AL shown above
- End panels are veneered face and back on 3/8" MDF
- Easily installed – packed all in one box

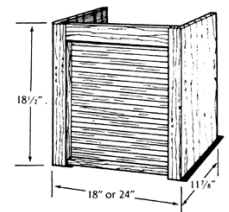

Red Oak **AG100SX24RO**

APPLIANCE GARAGE KITS -CORNER APPLICATION

- 18-1/2" high x 11-7/8" deep
- with 17" wide face frame
- Kit is complete with tambour door mounted to solid wood face frame
- Kits utilize the Spring Tension Track System ST2X24AL shown above

- End panels (angled at 45 degrees) are veneered face and back on 3/8" MDF
- Easily installed - packed all in one box

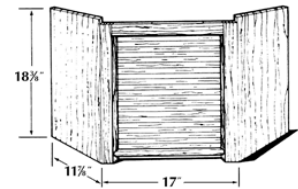

Red Oak **AG100CRO**

POLYMER DOOR MOUNT SUZAN installs in minutes, and won't need adjusting tomorrow. The horizontal, vertical, and rotational adjustment features save time and money. The unit is installer friendly.

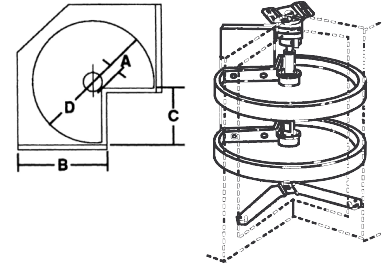

<u>STOCK NUMBER</u>	<u>COLOR</u>	<u>HEIGHT RANGE</u>	<u>A</u>	<u>B</u>	<u>C</u>	<u>D</u>
24PIE	Bisque	25"-33"	2-1/4"	15-1/2"	10-1/2"	24"
28PIE	Bisque	25"-33"	4-1/4"	19"	10-7/8"	28"

POLYMER KIDNEY SUZANS

<u>STOCK NUMBER</u>	<u>COLOR</u>	<u>DIMENSIONS</u>				<u>POST RANGE</u>
		<u>A</u>	<u>B</u>	<u>C</u>	<u>D</u>	
18 KIDNEY	Bisque	1-1/4"	8"	7/8"	18"	25-1/2" - 31-1/2"
24 KIDNEY	Bisque	2-1/4"	10-1/4"	1-5/8"	24"	25-1/2" - 31-1/2"
28 KIDNEY	Bisque	4-1/4"	10-5/8"	3"	28"	25-1/2" - 31-1/2"
32 KIDNEY	Bisque	6-1/4"	10-7/8"	4-7/16"	32"	25-1/2" - 31-1/2"

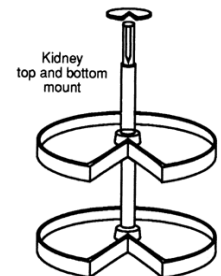
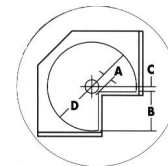

<u>STOCK NUMBER</u>	<u>COLOR</u>	<u>POST RANGE</u>	<u>SHELVES</u>
18 ROUND	Bisque	25-1/2" - 31-1/2"	2
28FRWHSET	White	26" - 34"	2
32FRWHSET	White	26" - 34"	2
18ROUND3	Bisque	35-1/2" - 40-1/4"	3

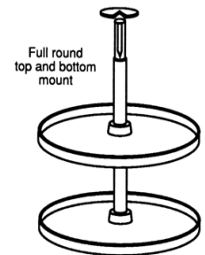

Diameter - 12"
 Stock Number - **12ROUNDSUSAN**
 Load Capacity - 1000



Rev-A-Shelf's TOT -LOK is a magnetically released lock for wood thicknesses of 1/2" to 1-9/16". 9/32" hole to be drilled for unlocking actuator. Sold individually

MAGLOCK Install one in each door behind which are hazardous materials.

MAGKEY the magnetic "key", Minimum of one per home required.

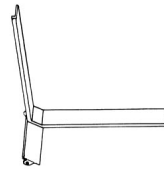
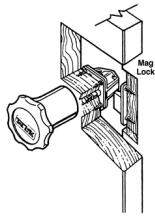

HALF MOON HARDWARE Hinge and brace assembly mate together to form a two-arm support system for a wood shelf (you make). Finish -White

<u>Stock #</u>	<u>Height</u>	<u>Width</u>
FRH7	5-1/2"	23"

WIRE PIE CUT BOTTOM MOUNT - Designed for utilizing the space in base corner cabinets, the wire pie cut suzans give visibility plus convenience. Hardware includes a device to re-position baskets after rotation to clear doors. Baskets move independently on bottom mount post. Stand alone unit - no need to top mount - just screw into floor.

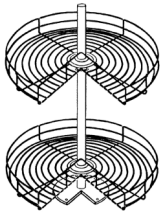

Finish -White

<u>Stock #</u>	<u>Diameter</u>	<u>Baskets</u>	<u>Height</u>
FPC24S *	24"	2	18-1/2"

HALF MOON GLIDE OUT HARDWARE not only pivots shelf out of the cabinet, but also glides it out an additional 13" on a heavy duty ball-bearing slide. Finish -White

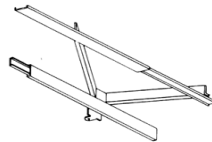

<u>Stock #</u>	<u>Height</u>	<u>Width</u>
FRH7G	5-1/2"	23"

WIRE FULL ROUND TOP & BOTTOM MOUNT- Baskets swivel independently on post which mounts at both top and bottom in the cabinet. Top mounting plug allows for 2" of additional height if required. Installs with 8 screws. Finish -White

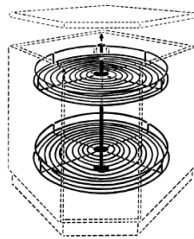

<u>Stock #</u>	<u>Dia.</u>	<u>Baskets</u>	<u>Height</u>
FFR20S3TM	20"	3	28-1/2"
FFR28STM	28"	2	28-1/2"

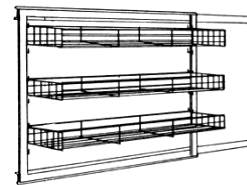

BASE CABINET ORGANIZER Designed to fit narrow "filler" cabinets. The BCO offers vertical basket adjustment and fits System 32 boring pattern. Bi-directional slides allow unit to fit either right or left-handed door applications. Units are sized to fit, base cabinets without drawer, includes 6 vertical basket adjustment positions. Suffix (4, 5, or 6) indicates size of BP basket to order separately. Finish - White

<u>Stock #</u>	<u>Depth</u>
* FBCO24566	22"
* FBCO20775	22"
FBCO20776	22"

WIRE HALF MOON GLIDE OUT -Slide mounted shelf pivots out of blind corner cabinets and extends 13" on a quiet, ball-bearing slides. Makes access into blind corner cabinets easy. Wire shelf includes 1-1/2" high fence to hold tall items upright. May be mounted either hinged right or hinged left.

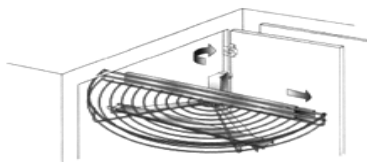

<u>Stock #</u>	<u>Min. Opening</u>	<u>Finish</u>
FHM25G	13-1/2"	White

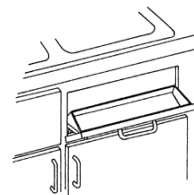

STAINLESS SINK FRONT TRAY Polished stainless steel tray turns wasted space into storage space. Has a built-in stop that prevents articles from tipping out. Height - 3" Depth - 2"

<u>Stock #</u>	<u>Width</u>
FSF11W	11"
FSF14W	14"
FSF19W	19"
FSF28W	28"
FSF31W	31"

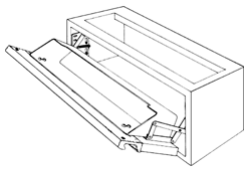

PLASTIC (WHITE) SINK FRONT TRAYS turn wasted space into storage space. Designed to be used with scissors hinge shown below, as these trays do not have built in stops.

Height -3"
Depth -2"

Stock #	Width
FPSF11	11"
FPSF14	14"

SCISSORS HINGES Self-closing concealed scissor hinge fits both traditional frame or contemporary frameless cabinet applications. Hinges open smoothly and evenly on any length panel. Suitable for both inset and overlay applications. Min. of 1" reveal required top + bottom.

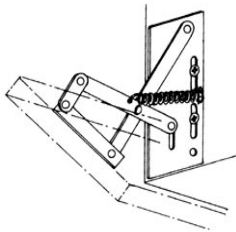

Stock # ~	Height	Width/pair
FSH	3-3/4"	3/4"

EURO-TRAY HINGES Great for sink front trays, and may have application in a stereo environment. May be adjusted for openings between 45° and 90°. Suitable for both inset and overlay applications. Mounting plates are epoxy coated white. Hinges are chrome plated.

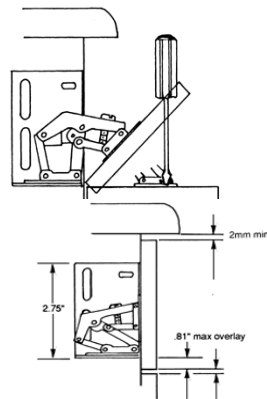

Stock #	Height	Width	Depth
---------	--------	-------	-------

FETH	2-3/4"	4" (pair)	2"
------	--------	-----------	----

Hinge opens flat (90°) for easy installation into existing cabinetry.

SYSTEM 32 BASKET is compatible with frameless cabinetry made from 5/8" end panels. Units simply plug into existing hole pattern with Euroscrews (provided). 16mm spacers are also included to allow baskets to clear door hinge. 22mm spacers are available.

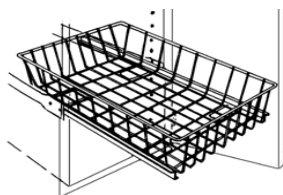

Stock No.	Opening Width	Cabinet Height	Depth
F321675	423mm 16.66"	4"	22"

VEGETABLE BIN ASSEMBLY is a self-contained three tier basket system is ready to install to cabinet floor with no assembly required. Ideal for storing vegetables, linen, toys, etc. Baskets slide out in coated steel channels. Mounting clips and screws included. Finish - White

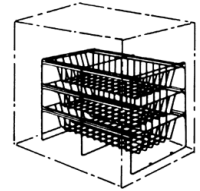

Stock No.	Width	Height	Depth
FVBA113	11"	19-3/4"	21-3/8"

UNDER SINK BASKET lets all the space around plumbing be used efficiently. Units have top baskets that mount to base basket, and may be mounted on either right or left side so as to avoid plumbing. Finish - White



Stock No.	Height	Width	Depth
FUSB11TM	10-1/4"	11"	18-7/8"
FUSB14TM	10-1/4"	14"	18-7/8"



MULTI-USE BASKET - The "Basic Basket" This sturdy, large capacity basket can be used for any storage need. Epoxy coated wire unit clips easily to base mounted slides. Installs with four screws on shelves or cabinet

floor. Sized for use in kitchen or vanity cabinets. Finish - White

Stock #	Width	Height	Depth
FMU11	11"	5"	18-3/4"
FMU14	14"	5"	18-3/4"

IRONING BOARD fits into a cabinet drawer space and conveniently pulls out when needed. Unit installs in about 20 minutes. Board pulls out on slides and in one motion, opens up and out for use. Complete with padded cover. FIB1232
Length req'd for installation: 23"
Board length: 33-5/8"
Board width: 12"
Min. space req'd: 4 x 13"

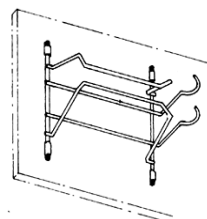
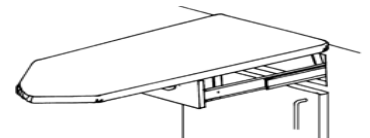

IRON HOLDER -the perfect accessory for the Presto- Board. Can be installed on cabinet door above or below board so iron will be readily available. Chrome plated/nylon mounting fittings.

Stock #	Height	Width	Depth
FIB-H	8-1/2"	9"	5-1/2"

LIFT-UP FITTING consisting of 1 - left guide arm with spring and latch, and 1 - right guide arm with spring & latch. Finish -White epoxy coated. **LIFTUPFITTING**

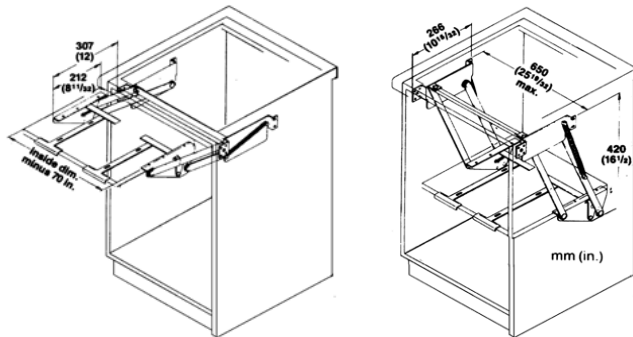
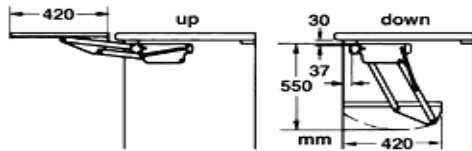

DOOR LADDER attaches to pantry door to provide an adjustable rack for FSB-1043 baskets. Rungs are spaced 2" standard nylon fittings. Finish - White

Stock No.	Height	Width
FDL5900	59"	11-3/8"

NYLON END FITTINGS are used with the above door ladder. They slip over the ends of the ladder, and then with pan head screws, are secured to the door. Sold individually. **FENDFITTINGS**

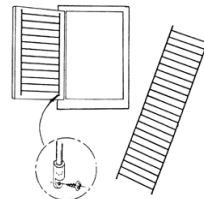

PANTRY ROLL OUT Heavy duty roll out unit provides maximum access to pantry space. Roll out allows any combination of BP baskets to be installed for complete versatility. Maximum storage capacity is 150 lbs. Finish - White

Stock No.	Height	Depth
FP4650	46-1/2"-54"	22"

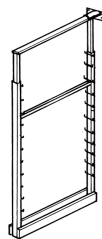

PANTRY & BASE BASKET mount to both the FB1700 Base Roll Out, as well as the FP series of Pantry Roll Outs. Finish - White

Stock No.	Height	Width	Depth
FBP4	3-1/4"	4"	21-1/2"
FBP6	3-1/4"	6"	21-1/2"
FBP10	3-1/4"	10"	21-1/2"

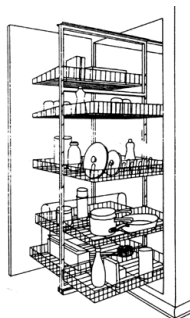

SLIDE-OUT WASTE BASKET Mounted on roller bearing, epoxy coated slides, these wastebaskets offer 30 quarts of storage capacity per bin. White plastic bin is included to match white finish of wire.

Stock No.	Opening Req'd	Depth
PSW10	19-3/4"h x 9-1/2" w	22"
PDMSW10	19-3/4"h x 9-1/2"w (door mounted)	22"

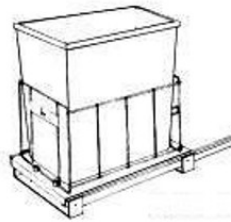

PSW10

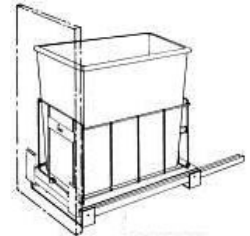

PDMSW10

BAG-IT-ALL Door mounted unit features a leak-proof bottom tray that slides out for cleaning. Unit holds a standard brown paper grocery bag. Finish - White

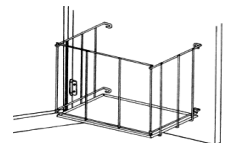

Stock No.	Unit Height	Height w/Sack	Req'd. Opening Width
FBIA	11"	17"	15"

TRASH BAG HOLDER can be mounted to fit a 14-1/2" opening as shown, or rotated 90° to fit a 9" opening (or to avoid plumbing obstructions). Holds a standard brown paper grocery bag within a wire cage on a solid white melamine board.

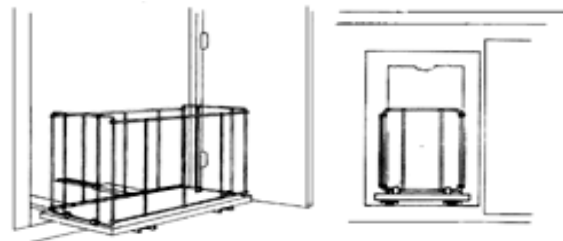

Stock No.	Height	Width *	Depth
FDD14	15-3/4"	14-1/2" or 9"	18-7/8"

*Add 3/4" if using Euro hinges.

ROTARY RECYCLING CENTER mounts in a 36" base corner cabinet and installs with 8 screws. Three removable 32 quart bins allow in-home separating of plastics, glass, metals, etc. Bins are easily removed for cleaning. Rotating mechanism is self-centering.

Stock No. **FRRC28K** Height 21" Width 14-3/8"

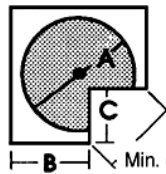
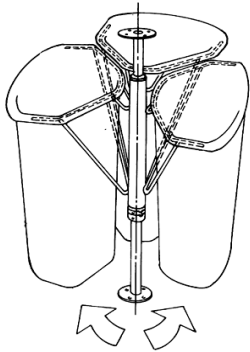

A diameter	28"
B min. inside cabinet	19"
C min. inside door	10"
Height adj.	28-1/2" to 30-1/2"
Color	White

Min. opening
14-3/8" wide x 21" high.

DOUBLE-TIERED CUTLERY SLIDE is a two-tier unit that comes pre-assembled with whisper quiet epoxy coated slides. Top drawer integrates with bottom drawer via slide and then slides back exposing bottom drawer.

Stock No. ***FCS2075** Int. Drawer Width 18-3/4" to 20-3/4" Clearance Height 3-1/2" min. Drawer Length 17-1/4" min.

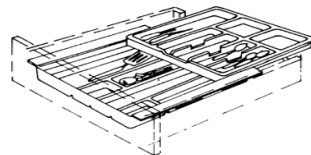
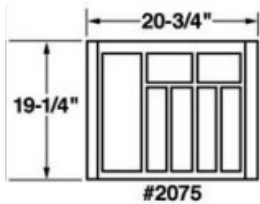

SPICE RACK has four tiers to help organize spices, condiments, cans, etc. The bottom tier is 1" deeper for items such as soup cans. Mounts directly to door using nylon end fittings.

Finish - White

Stock No. **FSR18** Height 19-7/8" Width 13-3/4" Depth 3-3/4"

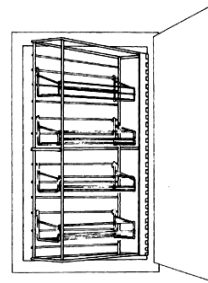
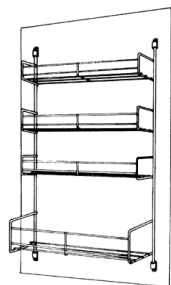

CANNERY ROW add convenience and organization to wall cabinets. Unit pivots out on hinge to expose half shelves in back. Baskets are vertically adjustable. Unit comes with four FSB-1043 baskets and closed position catch. Finish -White

Stock No. **FCR12** Height 24" Width 12-1/4" Depth 5"

TILT OUT HAMPER attached to a bottom hinged cabinet door and allows the door to be opened and the unit accessed in one easy motion.



Finish - White

Stock No. **FTO1716** Height 17-3/4" Width 16-1/2" Depth 18-3/4"